

MODEL BASED CONSTRUCTION PROCESS MANAGEMENT

Model based construction process management

J. LAITINEN

YIT Corporation, Helsinki, Finland

Durability of Building Materials and Components 8. (1999) *Edited by M.A. Lacasse and D.J. Vanier.* Institute for Research in Construction, Ottawa ON, K1A 0R6, Canada, pp. 2844-2863.

© National Research Council Canada 1999

Abstract

The purpose of this research was to study how the data management of a main contractor can be improved, in order to provide better client value and more cost-efficient production. The research focused on methods for reengineering the information management using product modelling as an enabling technology. The methods were tested in pilot tests in which the developed cost and value engineering prototype application was used.

This paper demonstrates an integration of design and production planning based on the product model approach. The final outcome is that the main contractor can utilise information coming from designers as input in its own tendering and cost estimation applications.

The key methodology used for describing the information management process throughout the building process life-cycle was IDEF0. The analysis of the current process (as-is), in the form of an IDEF0 model, helped in identifying the main problems of current practice. The target process (to-be) definition was based on product model utilisation and takes into account the possibilities for process reengineering supported by product data technology. One specific requirement was deemed important in view of the anticipated developments in the area of data exchange; the target system should be structured in such a way that it could easily be adapted to receive data according to the emerging Industry Foundation class (IFC) core model schemas.

The overall result of the research reported in this paper is that the product model approach can be used for a substantially reengineered information management process of a main contractor, especially in design and constructdesign/build type contracts.

Keywords: Cost estimation, information technology, process model, building product model, reengineering, knowledge engineering



1 Introduction

1.1 Need for reengineering the information management process

While other industries have been able to achieve very significant improvements in productivity and quality over the last few decades, the construction industry seems to have been at a standstill. The industry has not been able to combine high quality with productivity, customer satisfaction and flexibility. Competition remains mainly focused on lowest cost and offering capacity instead of quality, sustainability and customer-perceived value. The construction industry is, in particular, lagging far behind other industries in using modern technology as a major catalyst for improving its processes.

The information management methods used in current construction processes are inadequate. In particular, the traditional separation of design and production causes problems in the form of duplication of work, inconsistent documentation, etc. According to a study carried out in the UK (Latham 1994), 30% of the total building costs should be saved when information problems such as repeated work, overlapping work, false information, redoing, etc., are solved. Improved data exchange and the overall managing of the information will be a key solution to this. These problems can not be solved by more advanced IT tools alone. Reengineering of the process itself is necessary (Betts 1997).

1.2 IT-tools that support reengineering

Early developments in construction computing provided support for activities where information was created. Good examples are the use of CAD-systems for drawing production and spreadsheets for cost calculations. During the last few years new emerging IT-technologies have increasingly been used to facilitate information management and transfer in the construction process. Computer networking, document management systems, the Internet, database technology and interoperability standards provide examples of such technologies. The potential of these for data sharing has, however, not been fully utilised in the construction industry, but has rather been used for exchanging traditional documents in a digital format.

One promising technology for data exchange and sharing, the commercial use of which is still in its infancy, but which has been the subject of quite intensive research during the last decade, is product data technology (for a recent overview, please see Eastman and Augenbroe 1998). In product models the information about a product (in our case a building) is stored as information objects in databases, according to data structures which have been standardised. In contrast to today's practice information is stored only once and the needed documentation is produced from the product model using applications. Many European research projects, such as CIMSteel (1998), ATLAS (Tolman *et al.* 1994) and COMBINE (Augenbroe 1994) have developed methods for product model based information exchange. The development of the fundamental standards needed for building product data exchange is currently going on both as formal standardisation through the ISO STEP committee (ISO 1993), and through active industry participation in the Industry Alliance for Interoperability (IAI 1997), which is developing object-oriented building descriptions, so-called IFCs.

1.3 Aim and objectives of the research

The overall aim of this research was to study how the data management of a general contractor, who mainly aims at working in design/build projects, can be improved, in order to provide better client value and more cost-efficient production. For the client the key issue lies in the information provided for decision support. For the contractor the major improvements can be foreseen in the tendering activities as well in cost and value engineering management.

In order to achieve such improvements the operational target was to be able to manage requirements information, design and production information in an integrated manner throughout the construction process. In essence, this meant that the research focused on methods for re-engineering the information management of the main contractor, using product modeling as major enabling technology.

1.4 The Case company: YIT Corporation

This kind of research proposed, which includes wide scale testing of changed business processes, can only be possible to carry out in close co-operation with industrial companies in order to follow the strategic business targets of the companies and to verify the results in real projects. The research was carried out as a case study inside Finland's largest contractor, YIT.

YIT's Division for Building Construction is the leading contractor for residential, office and industrial facilities in Finland, with residential buildings constituting 55 % of its total production. Over 60 % of the production is carried out in design/build projects.

YIT Building Construction has an internal R&D -department, which focuses on customer decision supporting systems, quality systems and business process reengineering supported by enabling IT-technology.

2 Problems of the current information management process

2.1 Analysis supported by process modelling

In this study the construction process used today by the case company was analysed throughout the whole life-cycle of the process. The focus was on the main contractor's viewpoint and on information and process management, in particular in design/build type projects. The analysis was carried out through interviews with experts in the company, through studies of existing project documentation and internal company guidelines as well as a study of the software tools currently used in the company. The analysis work was supported by formal IDEF0 modelling (Marca and McGowan 1987; Laitinen 1998).

2.2 Shortcomings in information exchange

According to the study, the main shortcomings of the information management methods used by the contractor, either in "bid and construct" or "design/build" type projects, may be summarised in two main points:

- From the customer's point of view, the contractor cannot provide sufficient decision support throughout the process.

- From the contractor's own point of view; poor information and data management, especially concerning the integration and sharing of data.
Some major current problems are:
 - There are no tools to create enough information in the briefing phase to adequately support decision making and no capability to use information from reference projects as cases effectively.
 - Hand over and as-built information for users and owners is poor.
- The information exchange between designers and between designers and suppliers is usually limited to paper drawings and is thus slow.
- The information flow between designer and contractor is based on drawings. Contractors are not able to efficiently use design information as basic data in their applications.
- The contractor's systems do not work together (no internal integration). Information which has been input into one application cannot be transferred to other applications.
- In general, the feedback mechanism is poor. There is no upstream feedback from the use phase to briefing at the start of later construction projects. A consequence of this is that estimations for life-cycle economy and other assessments are based on very limited knowledge.

3 The enabling technology – product modelling

3.1 Fundamental elements of product data exchange

Product data technology can be defined as a set of IT methods, tools and standards for the development and implementation of applications for the management, exchange and sharing of product data. In product data exchange shared data is stored only once, in a product model from which the different participants in a construction project can retrieve data and to which they can add data. This is in contrast to the current document-centred approach in which the same information is often independently stored in several documents, making it difficult to keep track of changes. Figure 1 presents the conventional versus product model approaches.

3.2 The STEP and IAI standardisation efforts

The central effort in the development of product data technology has been the international standardisation work in ISO TC184/SC4 Industrial Data committee. The main result so far has been the so-called STEP-standard, officially known as ISO 10303 *Product data representation and exchange standard*. Details are found in Laitinen (1998).

The International Alliance for Interoperability (IAI) is a recently founded industry effort whose goal is to develop product data models for sharing information between software tools which are utilised throughout the Building Industry (IAI 1998). These models (or rather the class definitions that form them) are called Industry Foundation Classes (IFC). The IAI is a group of over 600 AEC related companies and organisations located throughout the world.

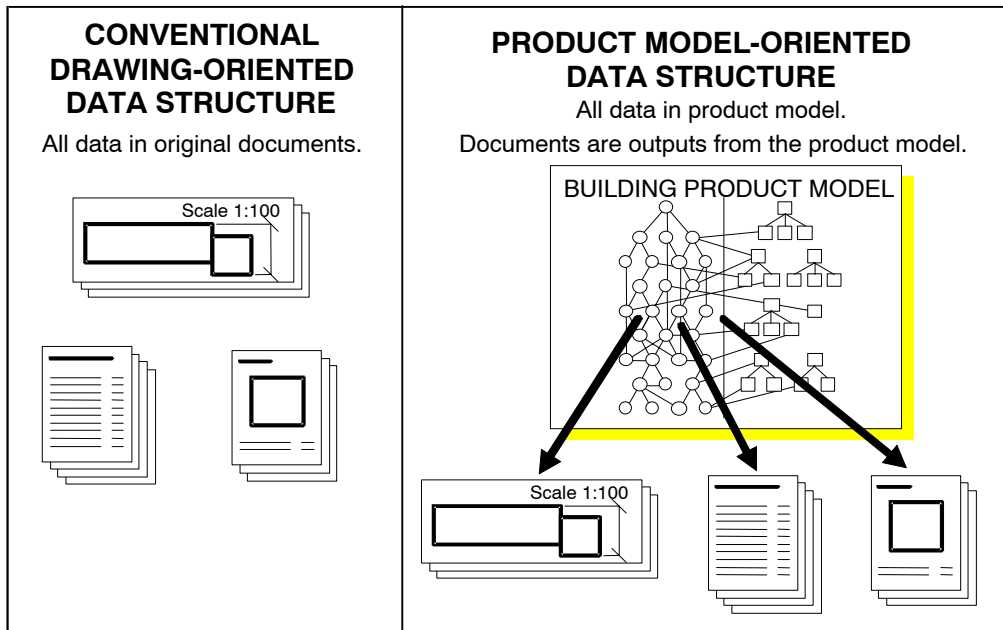

Fig. 1: Document-oriented approach versus proposed product model (Björk 1995)

After having been started as a relatively independent effort, the IAI has increasingly taken into use techniques that have earlier been developed within STEP. Thus the EXPRESS language and the STEP physical file format are used and there is quite a lot of reuse of models or parts of models. Discussions are also going on to reach an agreement ensuring that the duplication of effort is minimised and that the resulting standards – the STEP application protocols and the core model – and de-facto standards (IFCs) as far as possible are compatible or even the same.

3.3 Integrating product model data with process information

Since around 1991, a number of researchers have started to look at the problem of how to provide an infrastructure for integrating the possible future product models produced by designers with the software applications used by contractors for cost estimating and scheduling (Froese 1992), (Luiten *et al.* 1993), (Luiten 1994), (Fischer and Aalami 1995). The proposed solution has been to define conceptual schemas defining the relationships between building elements with the activities that produce them and the resources used. The term “construction project model” has been used for such schemas.

Currently there are a number of standardisation efforts where generic construction project models have a significant role to play. In a recent ISO classification report (ISO 1997) some conceptual schemas on a high level are also included. In the IAI development work the IFC core model already contains some generic classes related to construction activities. The project management domain group within the IAI has also started to develop more detailed models (Froese 1998).

4 The target information management process

4.1 Requirements and aims for the target process

The new proposed information management approach is based on the application of product model technology, especially for the purposes of cost and value engineering. The utilisation of the product model covers all phases of the building project. The aim is to integrate the information of the designers and the contractor in such a way that the data from the design work can be used as source data directly, without manual input, for calculating the tender as well as for production planning (i.e. the information produced by the designers is integrated with the contractor's know-how).

There are three main requirements for the target process:

- Provide more information and alternative solutions to the customer and the other participants within the building construction process.
- Provide more accurate information in earlier phases of the process.
- Utilise information created beforehand (cases) and classified technical solutions embodying the contractor's knowledge.

The target process is from a decision support point of view illustrated by Figure 2, which is based on the approach that key activities are shifting to earlier phases.

The traditional design process is divided into different phases of design, starting with briefing and ending with the production of working drawings. In integrated, model-based design, there is no such clear distinction between the phases: instead, the phases of the design process constantly interact and complement each other. The data content of the artefact being designed becomes more detailed and data accumulates continuously as the process advances. All new data are produced once only and are used as input data for the next 'phase'.

4.2 The high-level view of the target process

The top level of the IDEF0 model for the target construction process includes only one activity, *design and construct building* which defines the inputs and outputs of the entire building project. The second level (A0), shown in Figure 3, is a wider view where the model based construction process approach is described from the customer's, contractor's and building user's point of view.

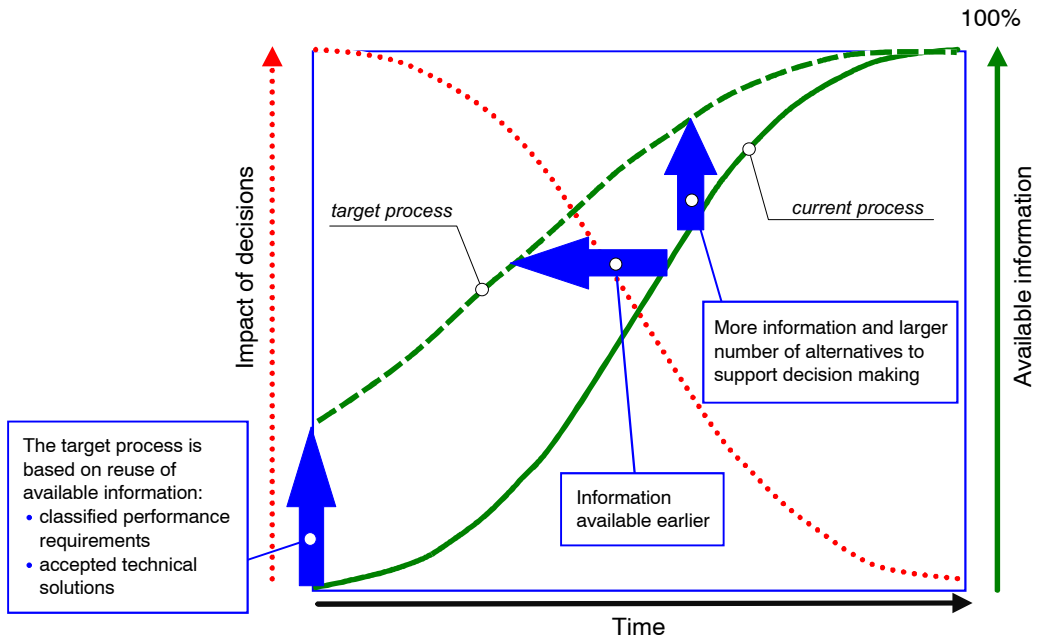

Fig. 2: Decision making versus available information
 (Adapted from Fisher *et al.* 1993)

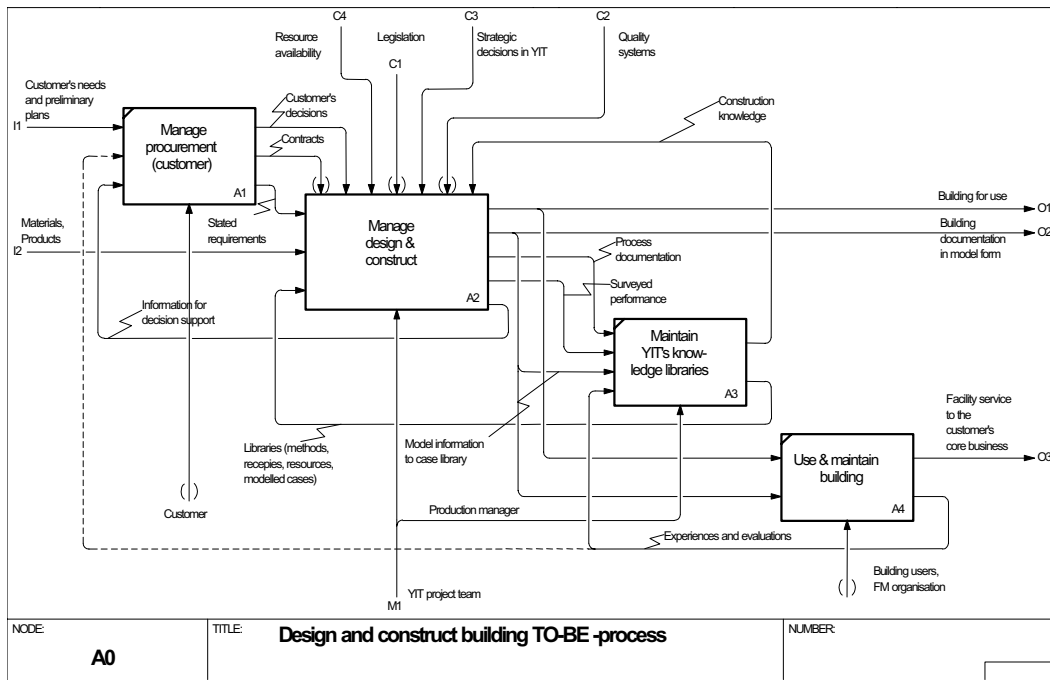

Fig. 3: Design and construct, to-be (A0)

The activity *customer's procurement process* (A1) is, compared to the current situation, based on more accurate information for decision support coming from the contractor's activity *Manage design and construction* (A2).

The contractor's activities, *Manage design & construction* (A2) and *Maintain YIT's knowledge libraries* (A3), are supporting each other better than in the as-is process. The main inputs for the knowledge libraries are model information to case library, process documentation and surveyed performance. The libraries are organised according to the building type (e.g. apartment buildings, office buildings) so they can be used as cases and as construction knowledge to control future projects. There are approved YIT-solutions for systems, production methods and structural details. The evaluation of the production performance improves the accuracy and reliability of recipes and methods which are inputs (libraries) for design and construction management and thus forms the basis for constant/standard work unit scheduling. The feedback from the activity *Use and maintain building* (A4) improves the life-cycle performance knowledge in the YIT-libraries.

4.3 Manage design and construct

The activity *manage design and construct* (A2) is shown in Figure 4.

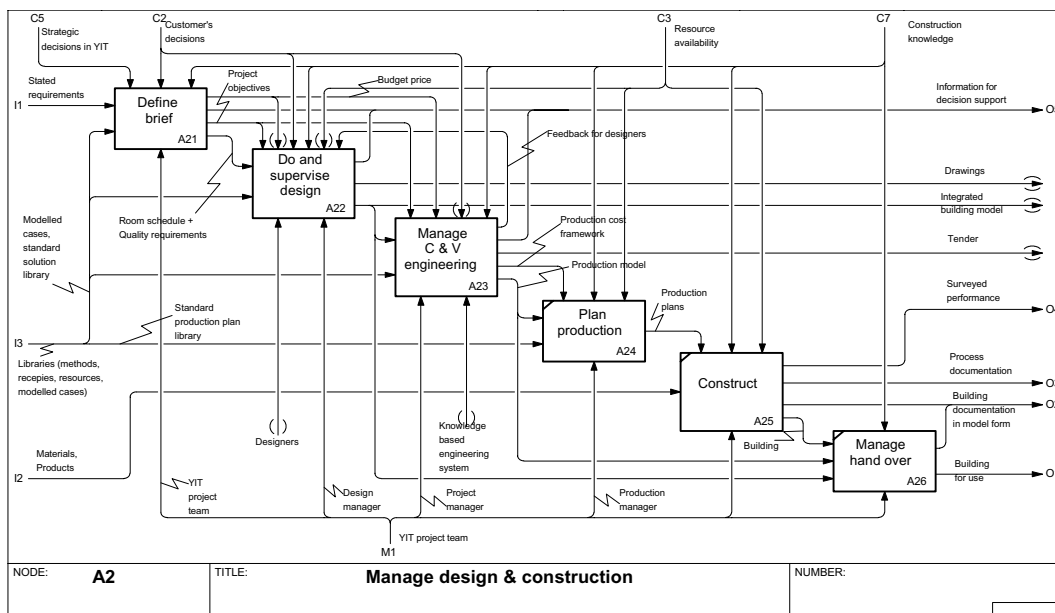

Fig. 4: Manage design and construct (A2)

The briefing phase, *Define brief* (A21), results in a space utilisation plan together with quality requirements, the expression of which in model-based design is a preliminary architect's aspect model including quality specifications on a per space basis. This serves as the basic data for the integrated building product model to be made in the design phase.

In *Do and supervise design* (A22), the designers each make their own part of the product model, which the contractor evaluates and gives feedback on. The integrated model based design process starts out with the architect's draft aspect

model, which models the building's shape, spaces, structural allocations (enclosing walls, ceiling/roof and floor) and the quality standard. After that, the structural engineer models the structures on the basis of the architect's allocations, possibly suggesting necessary modifications to the architect. Similarly, the installation designer models the technical conduits and furnishings according to the architect's space model.

The building product model grows and becomes more detailed throughout the design phase. At the *Manage C&V engineering* (A23) stage, the model contains all the design data for the building and the basics for design solutions as well as the planned production methods. After the integrated design phase, the production model data are used in the production planning and construction phases.

In the *Production planning* (A24) phase, data is used for planning time schedules, purchases and logistics. In this phase especially the knowledge of quantity and location data of building elements is used. Data specified once need not be measured again as they can be downloaded from the production model in the desired form, for example as partial outputs of wall panels or building frame structures.

The feedback from the phases *Construct* (A25) and *Manage hand over* (A26), serves as a guiding factor for the early activities in upcoming projects. These are modelled as outputs of the *Manage design & construction* activities, and are used as input in the *Maintain YIT's knowledge bases* activity. Experience data is also stored in the case library of modelled projects in YIT's knowledge bases. Final output is not only the building ready for use but also an as-built model for owners and occupants.

4.4 Manage cost and value engineering

The design solution data is analysed and evaluated during *Manage C&V engineering* (A23), Figure 5. This phase covers the composition of the production model using the contractor's knowledge-based application. Proposals for changes to guide design work are produced as a result of the process, e.g. changes due to analysis of alternative solutions like production methods etc. The practical implementation of the process procedures (mechanism) necessitate the use of knowledge based engineering techniques (KBE). Data on production engineering are transferred to other partners in the form of partial models from the production model as necessary, especially when alternatives are being investigated.

The *Analyse the design* (A231) activity involves analysing the scope, efficiency, form and functionality of the design solution, partly based on statistical methods and comparative data from other, similar projects. Co-operation with the user would be highly advisable for the assessment of the building's functionality.

In the *Compose production model* (A232), the contractor's know-how is added to the building product model. Aspect product models transferred by the neutral model are put together into the building's product model and then composed into the contractor's production model. Default production methods for the production qualities of the product model's components are accessed from the 'case' library according to the project type. This covers all production knowledge, methods, recipes, resources, materials and equipment needed to accomplish the building.

Basic data for the time scheduling application is generated using the production model, which is used to produce a provisional schedule for the project. The activity *Make schedule and plan construction* (A233), includes both the making of a schedule for the project and the analysis of the construction plan and especially its constructability. The schedule guides and to some extent restricts alternative forms of product planning, which helps to control costs. This activity seeks alternative solutions for production.

In *Study alternatives and make proposals for modification* (A234), the economy of the project is determined. *The Make alternative calculations* (A235), covers examining the cost impact of the alternative solutions put forward to designers, for instance concerning the most economical space solution, the most economical alternative structure in production terms or the cost impact of the client's requests for changes.

The determination of comparative calculations, like those of the overall costs, should be based on the contractor's own cost database, methods and recipes as well as the associated real-time input prices, so that costs can be assessed with precision even at an early phase.

The assessment of life-cycle economy generates a calculation of the costs of using, maintaining and repairing the building throughout its service life. The assessment of these costs is based on estimated repair and maintenance at calculated intervals according to the usage of the spaces.

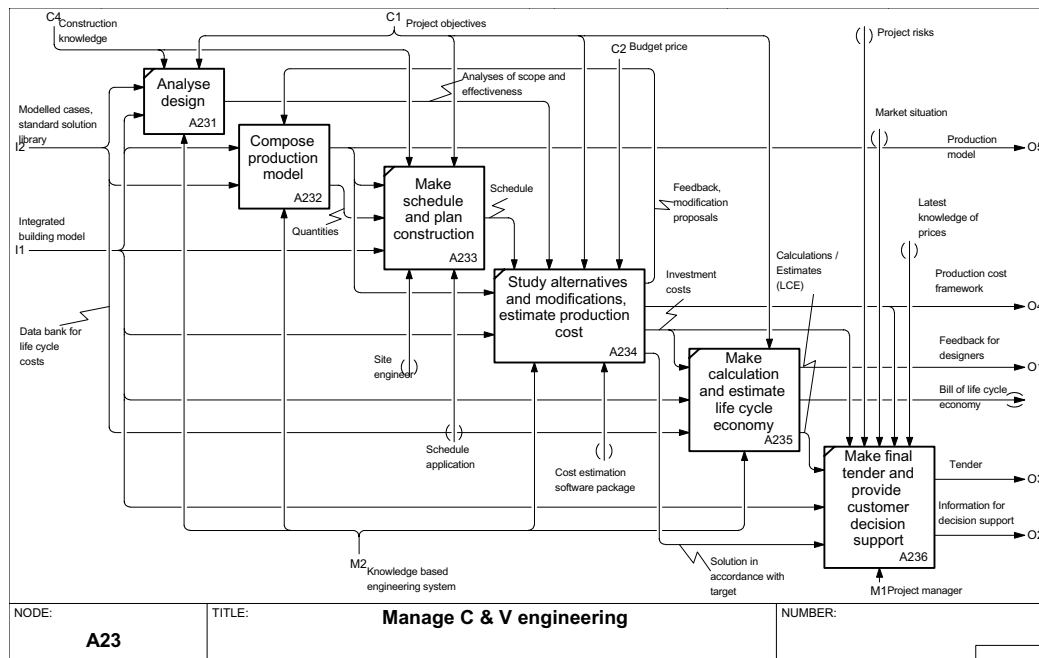

Fig. 5: Manage cost and value engineering, to-be (A23)

The final tender and documentation will be produced in *Make final tender for the customer and create decision support* (A236). This information forms the decision base of the analysed alternatives, their impacts and reliable calculations.

Due to the utilisation of the production model it is easy and quick to make alternative calculations in order to evaluate their impact on the costs and production. The life-cycle economy evaluations in terms of energy and cost are possible to do using the same production model and data bank of life-cycle costs.

A comprehensive presentation of the target IDEF0 model, as well as the current as-is process model, can be found in (Laitinen 1998).

5 Technical solution

5.1 Choice of basic platform

For the prototype work the Design++ system was chosen as a basic software platform. Design++ is a knowledge-based engineering (KBE) tool for engineering and design automation, which supports both engineering decision-making and drafting tasks (Katajamäki 1991). The underlying data model of Design ++ is a frame-based representation, which has been quite a popular representation mechanism used in knowledge-based system. In the earlier versions the core of Design++ was based on the KEE environment, which has originally been programmed in the LISP language, but later versions are programmed in C and C++.

In addition to the knowledge-based core Design++ also incorporates a commercial CAD-system and a relational data base system. This is because the CAD-system has a good user interface and good facilities for manipulating the geometrical aspects of a model, and because a data base system is good for storing and searching in large repositories of homogeneous data, for instance about components.

The parts and assemblies used in a model are defined as classes in libraries. A class must exist in a library before creating an object (instance) of it. Once a component (object, instance) is created in a model it may have local individual attribute values that can be modified.

The attributes of classes are defined interactively using tools provided with the user interface. Rules that are attached to class attributes can be used to capture the expertise used in the design process.

The library classes are defined in a hierarchy, which is represented graphically by a tree. A class can be defined broadly and then refined into successively finer subclasses. Each subclass incorporates, or inherits, all of the properties of its superclasses and adds its own unique properties. A subclass may inherit properties from more than one superclass (multiple inheritance).

5.2 The apartment building product model

The data exchange paradigm of the prototype system (Serén *et al.* 1996) complies in general well with the principle of a core model supported by aspect models, which was presented in section 3. The *apartment building product model* is the union of all the model data created by any of the project participants and which describes the apartment building as a product.

The *apartment building core model (ABCM)* is that subset of the apartment building product model in which more than one participant has an interest and

may need to access. An example of data structures included in the ABCM is shown in Figure 6.

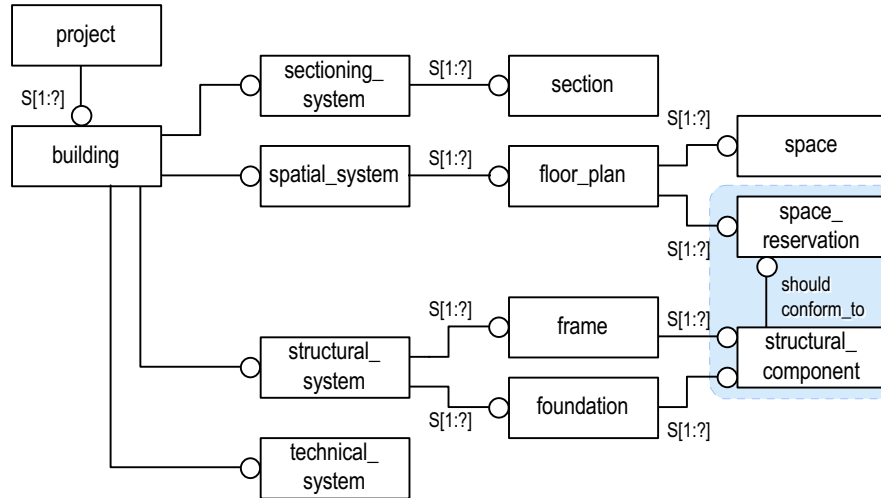

Fig. 6: ABCM model: decomposition hierarchy view (Serén *et al.* 1996)

The *architect's aspect model* contains all the information in which the architect is interested. Part of this data is also important for the other participants (for instance the placement of walls) and belongs consequently to the ABCM. This part can also be information created by other parties which has relevance for the architect. Other data, such as the colour of walls, is not relevant for any of the other participants and belongs to that part of the architect's aspect model which doesn't intersect with the ABCM.

The *structural engineer's aspect model*, the *building services engineer's aspect model* and the *contractor's aspect model* are defined in a similar way.

The *contractor's production model* is the union of the contractor's aspect model, which is a subset of the overall building product model, and the relevant information on recipes and methods (here been called the production knowledge) needed to produce the building components.

The management of the logical contents of the shared information relies on the knowledge-based tool used by all the partners, and some solutions are based on the specific features of this tool. The product models of each partner are structured according to the common model (ABCM) implemented as standardised class libraries shared by all partners. The partners are able to specialise these classes according to their own needs in their applications which deal with the information belonging to their aspect models. In addition, a basic reference product composition structure file is used.

5.3 Data exchange format

Using this meta-model meant that mapping software had to be developed from the ABCM model to the OOCAD meta-model, and vice versa. Most of the information contained in the ABCM can be transferred; design rules and knowledge can not be transferred as such.

Figure 7 is an overview of the mappings included in the data exchange (from a participant's aspect model to the core model ABCM and from the core model to the data exchange model)

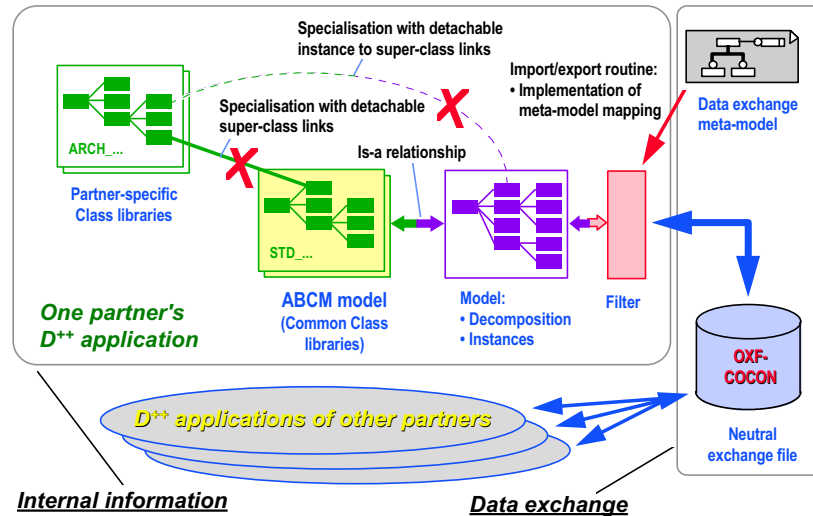

Fig. 7: Overview of the different mappings

5.4 Network solution for the data exchange

An Internet-based network solution was chosen as the basic infrastructure for the pilot integration environment. The pilot project was one of the first attempts in Finland to use the Internet for data exchange in real-life building projects.

The physical network connections and system administration are based on a centralised project server, to which the partners have access via Internet connection services. The individual aspect models of each partner are used locally and only the common class libraries belong to the ABCM and the data exchange files are distributed via the server. Typically the partners use modem-based dial-up connections. The project server is set up with home directories for each partner. Each partner has full read/write access rights to his own directory and read-only access to the other directories. The directory system is password-protected.

5.5 The Cost and value engineering system, COVE

YIT's production model is created by the so-called "COst and Value Engineering" system, for which the abbreviation COVE will be used in the following. This application is based on the corporation's knowledge of its own production: structural solutions, production methods and recipes and input price lists of resources and equipment.

COVE's own application-specific libraries include the attributes required to analyse costs and scope data. Eventually life-cycle economy and environment will be added when that kind of knowledge of building materials and products becomes available. The COVE libraries are linked with superclass link to the standard ABCM libraries shared by all participants.

The overall structure of the COVE model complies with the product structure of the ABCM core-model. In the class specification, an apartment building and the structures and spaces used in it have for the time being been taken as the reference point.

In COVE a building is decomposed into a spatial system, a structural system and an installation system (building services) corresponding to the architect's aspect model, the structural engineer's aspect model and building services designer's aspect model, respectively.

For each product structure class, interface functions have been developed for the creation of components and for specifying and checking attributes through interface windows. The options in the interface windows are the values of the production model components' production attributes, i.e. production knowledge. The production model components generated in the case of integrated design are in a similar way given their attribute values.

5.6 The creation of the production model from the designers' product model

In the case where the designers are already using product-modelling tools, which is not the current practice, the COVE system can use designer's output data as input data directly. As described above, the ABCM core-model sections modelled by the various designers are transferred into the COVE application by OXF data communications using mapping software.

After the product model has been created or imported it is processed by adding to it production know-how (to the building elements), either in the form of default values or by the interactive (through the user interface) selection of methods individually or for the various types of building elements. After the inspection of the product model and the addition of production know-how, the result is a production model that will serve as input data for production requirements. The production model is created quickly using the information in the ABCM core-model and with little extra work for the contractor. The COVE model can also be created using only a part of the ABCM core-model. For example, a structural model made by a structural engineer may be used, augmented with COVE for the spaces. The COVE model of a typical apartment building is illustrated in Figure 8.

5.7 The creation of the production model from paper drawings or CAD-files

The structure of COVE is such that the creation of the production model is also possible without the imported product model data. In this case the model is built interactively by the cost analyst through interpretation of paper, or CAD-drawings (in the format of AutoCad dwg files) emanating from the designers. In this case the creation of the product model and the production model are integrated and performed simultaneously.

The modelling of the building may be performed with the help of tools built into the interface application, to facilitate fast and simple routines for drawing components and attribute specification. The production model is created solely through the interface functions; i.e. the model and its components are built up as the user 'draws' the building and its structural elements.

The dependencies between components are clearly defined when they derive from the product structure hierarchy. This is a 'part-of' relationship between components. Some 'connected-to' relationships are also used in the COVE model, the expression of which is less distinct. Such a dependency may occur, for

example, between spaces and the walls (or similar structures) surrounding it when space components are created.

The object-oriented nature of the COVE model makes it easier to create and process a model. When constructing the model, it is possible to use the components' copying attribute in such a way that, for example, the load bearing structures of a high-rise apartment building are modelled in the lowest storey and copied 'upwards' on other, similar storeys. Similarly, the apartments are modelled on the bottom storey and copied upwards. Also, when making changes to the attributes of the production model's components, they propagate to all similar cases in the model in question.

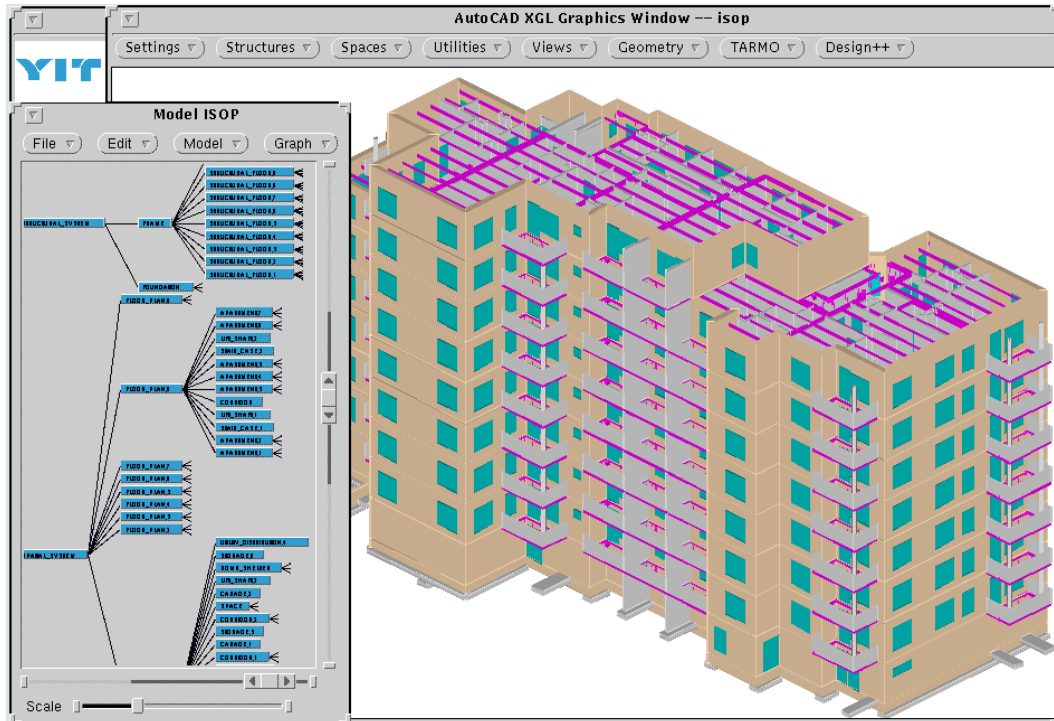

Fig. 8: User interface and the model with hierarchy in the COVE application

Determining the geometry of a component takes most time when it is derived from an architect's drawings on paper. In this case it is necessary to measure the geometrical information of the building elements with a ruler and enter them in numerical form while creating the components.

Modelling is simplified if the architectural plans are available as CAD-files. In this instance an architecture layer is formulated from each storey, and this is used as the base image in AutoCad. In the modelling of the building the architectural layer is used to 'draw' the geometry of the components, a process that resembles digitising.

6 Discussion

6.1 Comparison of the results with other published research

Although the results of the analysis of the current process, presented in section 2, are based on an analysis carried out inside one case company, they are very much in line with similar results reported by other researchers (Aalami and Fischer 1998; Froese 1992). The main conclusions are that the current document-based data exchange offers insufficient support for the customer's decision making in early stages and for reuse of already created data later on in the project management process.

Some visions on how to use product modelling as an enabling technology for reengineering the processes of individual construction companies have been published (Yamazaki 1990). The author isn't aware of other examples of re-engineered construction company process models, such as the one developed in this research and presented in section 4, which would have been reported in the research literature. Although there are a number of on-going R&D projects which include such modelling in their scope (i.e. the European CONCUR project (Storer and Los 1997). There are two likely reasons for this; firstly that formalised techniques like IDEF0 are seldom used by companies in the construction industry, secondly that companies are unlikely to publish the results of such modelling efforts.

The architecture of the prototype supporting the re-engineered process (Section 5), based on a core model supported by aspect models and a production model, can be compared to models defined by other researchers. In the PreFacto system (Jägbeck 1996) the generic product data model holds a core of information needed for managing a construction project. Also in PreFacto the product description is based on a neutral core model solution influenced by STEP. The information is imported from design documents and is used as input for creating PreFacto's own aspect model (a Production Management Model), which is quite similar in scope to the contractor's production model of this study.

The minimal NICC (Neutral Intelligent CAD Communication) conceptual schema (Tarandi 1998) specifies the use of concepts for the exchange of computer interpretable information relating to all parts of buildings. NICC contains building object shape and type, connectivities, assemblies and graphical representation. The production aspect is not as pronounced in NICC as in the COVE-application, which includes production knowledge in terms of methods and recipes.

Luiten and Fisher have tested the usefulness of a conceptual project model and system architecture as information models for integrated construction management in the prototype system called SPACECAKE (Luiten and Fischer 1995). The conceptual project model was built up of project classes and their attributes and relationships. The main finding was the need for the development of computer interpretable representations of construction knowledge, which complies well with the direction of this study.

6.2 Experiences of the YIT staff

The following discussion is based on interviews made with YIT staff after the pilot projects and after some other test projects, and with staff from design offices during and after the pilot projects.

The examination of the extent of the building and of the various characteristic figures is based on the user's conclusions drawn from the COVE calculations. The way these characteristic figures are used has so far depended entirely on the user's skills and experience. In addition to the easy calculation of these traditional characteristic figures, COVE enables the calculation of many characteristic figures, which can be derived from the shape, and the quantities of various construction elements described in the model. So far there is no experiential basis for the comparison of these. As the number of models rises, and as systematically compiled statistical materials accumulate, the possibility arises of analysing the data on the basis of comparative statistics, which will yield information on the importance of these characteristic figures to design management.

The examination of the functionality of a design solution is still performed through a graphical user interface. In other words, the user examines the designs with AutoCad images and draws conclusions on the basis of his own knowledge. It was found that these requirements are difficult to describe as design rules for the system (Design ++).

A cost estimation produced with the COVE model currently covers about 60% of a full cost estimation. At present, the information generated by the production model can be used to determine the costs of spaces and structures, but the costs of technical systems, foundation works and site engineering must for the moment be determined separately for each project by traditional methods. Enhancements to the system are essential so that an all-inclusive cost estimation can be obtained.

It is possible to carry out comparative estimates by generating a transfer file from a limited set of components, e.g. facade elements or the building frame. In the initial phase of modelling it is possible to estimate the design by determining a cost estimation for the loadbearing structure alone. The quantity of the loadbearing frame and its cost are appropriate points of comparison also for assessing the scope of design. This feature was found very useful by the staff involved.

The required design data can be taken from the production model by inspecting the model from various perspectives, viewing only the needed components and attributes in isolation. This open product structure was found very useful in particular to procurement operations, in which the modules required by the building component trade can be freely demarcated and assembled together. Precise data on quantities and designs can be appended to tenders, so the supplier's quantity estimation is left out and the risks inherent in the supplier's tender are reduced as the appended material becomes more accurate.

As a conclusion of the experiences so far the interviews indicated that the achieved accuracy is acceptable and the savings in time are about 80 %. Also most mechanical and human errors are avoided and in addition it is always possible to check the model using visual Auto-Cad images. Alternative design and production solutions are relatively easy to create and quick to evaluate.

The most probable way in which the COVE application will be used in the near future is for modelling production models by the contractor's design management and estimation staff. Using AutoCad files as a basis for modelling is, for the time being, a convenient modelling method. Modelling on the basis of AutoCad image files was in the pilots found to be considerably faster than working with drawings on the paper. The time taken to precise modelling from paper drawings can be estimated as two to three times the time taken to model with AutoCad files (comparisons made in typical housing projects). However, the most important achievement according to the production planners is that now the information is in usable form for other activities (production planning, scheduling etc.) in later phases.

In summary the proposed main contribution of this research is that the product model approach can be used as the technical means for a substantially reengineered information management process of a main contractor. Although the testing is not complete, it goes a longer way into full-scale testing in an industrial setting than most of the reported building product model research. This type of applied research is very much needed to provide the "proof-of-concept" of the utilisation of product models within the construction industry, which is needed to convince company managers to go ahead and invest in reengineering the way their companies work.

7 Acknowledgements

The research presented in this article would not have been possible without the financial support of the YIT Corporation and the Finnish Technology Development Centre (TEKES).

8 References

- Aalami F., Fischer M., (1998) Joint product and process model elaboration based on construction method models, In: Björk B-C and Jägbeck A. (eds.) *The life-cycle of IT innovations in construction – Technology transfer from research to practice*, Proc. CIB W78 conference, June 3-5, Stockholm, Royal Institute of Technology, Dept. of Construction Management, Stockholm.
- Augenbroe, G., (1994) An Overview of the COMBINE Project, In: *First European Conference on Product and Process Modeling in the Building Industry*, Dresden, Germany, 5-7 October.
- Betts, M., (1997) Lean production as a purpose for computer integrated construction In: Alarcón, L. (ed.) *Lean Construction*, A.A.BALKEMA, Rotterdam, pp. 343-353.
- Björk B.-C., (1995) *Requirements and information structures for building product data models*, Doctoral dissertation, VTT publication 245, Technical Research centre of Finland, Espoo.
- CIMsteel, (1998) *CIMsteel on the Internet*, WWW-CIMsteel, <http://www.leeds.ac.uk/civil/research/cae/cimsteel/Cimsteel.htm>

- Eastman, C., Augenbroe F., (1998) Product modelling strategies for today and the future In: Björk B-C and Jägbeck A. (eds.) *The life-cycle of IT innovations in construction – Technology transfer from research to practice*, Proc. CIB W78 conference, June 3-5 1998 Stockholm, Royal Institute of Technology, Dept. of Construction Management, Stockholm.
- Fischer, M., Aalami, F., (1995) *Scheduling with Computer-Interpretable Construction Method Models*, CIFE Working Paper, Center for Integrated Facility Engineering, Stanford, CA, June.
- Fischer, M., Betts, M., Hannus, M., Yamazaki, Y. & Laitinen, J., (1993) Goals, dimensions, and approaches for computer integrated construction, In: Mathur, K., Betts, M. & Tham, K.W. (eds.) *Management of information technology for construction*, Singapore: World Scientific Publishing & Global Publications Services, pp. 421–433.
- Froese, T., (1992) *Integrated Computer-Aided Project Management Through Standard Object-Oriented Models*, Ph.D. thesis, Dept. of Civil Engineering, Stanford University, Stanford, Ca, USA.
- Froese T., (1998) Developing Data Standards for Construction--An IAI Perspective, In: Björk B-C and Jägbeck A. (eds.) *The life-cycle of IT innovations in construction – Technology transfer from research to practice*, Proc. CIB W78 conference, June 3-5 1998 Stockholm, Royal Institute of Technology, Stockholm.
- IAI (1997) *IFC Object Model, Release 1.5*, In: CD-ROM, Industry Foundation Classes Release 1.5 – IAI Members CD, International Alliance for Interoperability.
- IAI (1998) International Alliance for Interoperability, *Defining a Universal Language for Collaborative Work in the Building Industry*, <http://www.interoperability.com>, Mar. 15.
- ISO (1993) *Product Data Representation and Exchange - Part 1: Overview and Fundamental Principles*, ISO DIS 10303 TC 184/SC4, Geneva: International Organisation for Standardisation.
- ISO (1996) *Product Data Representation and Exchange - Part 106: Building Construction Core Model*, ISO/TC184/SC4/WG3 Working Paper N496, Geneva: International Organisation for Standardisation.
- ISO (1997) *Organisation of Information about Construction Works - Part 2: Framework for Classification of Information*, ISO/TC59.
- Jägbeck, A., (1996) PreFacto - A Construction Management Tool Using Product Model Data, In: Kumar, B. and Retik, A. (eds.). *Information representation and delivery in Civil and Structural Engineering Design, Proceedings of ITSCED '96* in Glasgow 14-18th August. Civil-Comp Press, Edinburgh, pp. 199-207.
- Katajamäki, M., (1991) Knowledge Based CAD, In: *Expert systems with applications*, vol 3, Pergamon Press, USA, pp. 277-287.
- Laitinen, J., (1998) *Model Based Construction Process Management*, Ph.D. thesis, Royal Institute of Technology, Stockholm.
- Latham, M. Sir, (1994) *Constructing the Team, Joint Review of Procurement and Contractual Arrangements in the United Kingdom Construction Industry*, DDP Services, July.

- Luiten G., Froese T., Björk B.-C., Cooper G., Junge R., Karstila K., Oxman R., (1993) An Information Reference Model for Architecture, Engineering, and Construction, In: Mathur K., Betts M., Tham K. (eds.) *Management of Information Technology for Construction*, World Scientific & Global Publication Services, Singapore, pp. 391-406.
- Luiten, G. T., (1994) *Computer Aided Design for Construction in the Building Industry*, Ph.D. thesis, Delft University of Technology.
- Luiten, G. T., Fischer, M., (1995) *SPACE CAKE, System for Project Management in Civil Engineering using Computer-Aided Knowledge Engineering*, CIFE Working Paper, Number 40, Center for Integrated Facility Engineering, Stanford, CA, May.
- Marca, D. A., McGowan, C. L., (1987) *SADT-structured analysis and design technique*, New York, McGraw-Hill.
- Serén, K.-J., Hannus, M., Karstila, K., Kihlman, M. and Pellosniemi, J., (1993) *Object-Oriented CAD Tool Implementations for the Construction Industry*, VTT Research Notes 1460, Laboratory of Structural Engineering, Technical Research Centre of Finland, Helsinki, Finland.
- Serén, K.-J., Hannus, M., Laitinen J., (1996) Integrated Design and Planning in Building Projects-System architecture, Implementation and Experiences, In: Kumar, B. and Retik, A. (eds.). *Information representation and delivery in Civil and Structural Engineering Design, Proceedings of ITSCED '96* in Glasgow 14-18th August 1996. Civil-Comp Press, Edinburgh.
- Storer, G., Los, R., (1997) Taking Control of the Building Process, *European Conference for Industrial use of Product Data Technology*, CSTB, Sophia Antipolis, France, April.
- Tarandi V., (1998) *Neutral, Intelligent CAD Communication – information exchange based upon a minimal schema*, Ph.D. thesis, Royal Institute of Technology, Stockholm.
- Tolman, F., Bakkeren, W. and Böhms, M. (1994). *Atlas LSE Project Type Model*. ESPRIT Project 7280--ATLAS/WP1/Task 1500 Document D106-Ic, April.
- Van Nederveen, S., (1993) View integration in building design, In: Mathur, K., Betts, M. & Tham, K.W. (eds.) *Management of information technology for construction*. Singapore: World Scientific Publishing & Global Publications Services, pp. 209–221.
- Yamazaki, Y., (1990) Integrated design and construction planning system for computer integrated construction, Preproceedings of the *Computer Integrated Construction*, CIB Working Groups W78 and W74, Architectural Institute of Japan, Tokyo.